



CT 20 bars
300 PSI



Maximum
safety
Minimum
complications



Vygon strives to provide clinicians and patients with a **complete range of vascular access products of the highest quality.**

The Vygon Vascular Access range is designed with smart integrated solutions to come closer to the **ZERO COMPLICATION TARGET.**

Minimum complications

Our Vygon vascular access product range was designed as a **comprehensive solution bundle** to prevent complications:

- **Smoother insertion procedure:** Custom sets for maximal barrier precautions, quality insertion equipment and options for recommended insertion techniques such as safety needles. Those solutions are designed to improve insertion success rates, and to reduce complications and infection rates.

- **Complication-free care and home-care solutions** for appropriate catheter use, dressing, cleaning, flushing and upkeep.



Optimal placement

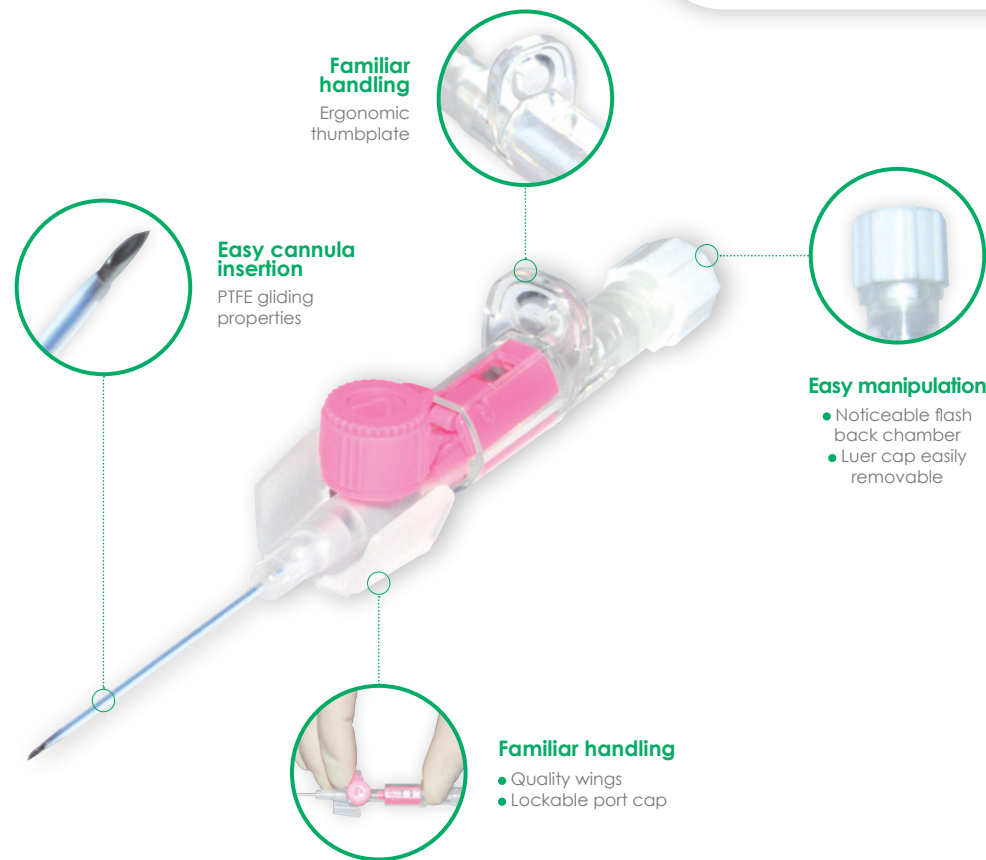

Maximum safety

The Biovalve Safe is a ported peripheral IV cannula designed to **protect the health-care worker from accidental infections** due to needlestick injury or blood splatter. It integrates an engineered passive safety system.

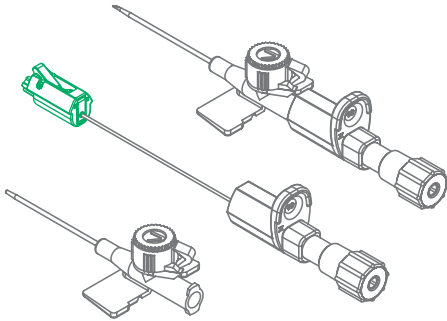

Passive Safety system

- **Triggers automatically** without changing the normal procedure of a peripheral IV cannula placement
- **Prevents needlestick injury** by capturing the needle tip into a safety cage
- **Prevents blood exposure** by trapping the blood drop at the needle tip and avoid it from splattering

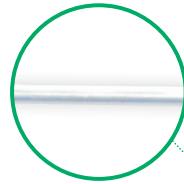

Optimal use

- Radio-opaque lines for good traceability in case of cannula embolism
- CT-rated 350 PSI

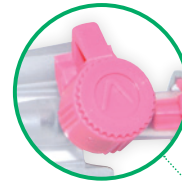

Optimal use

Snap cap for easy opening and closing

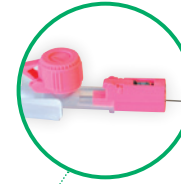

Smooth safety mechanism

- Smooth first and second separations
- Low-resistance gliding of safety cage along the needle

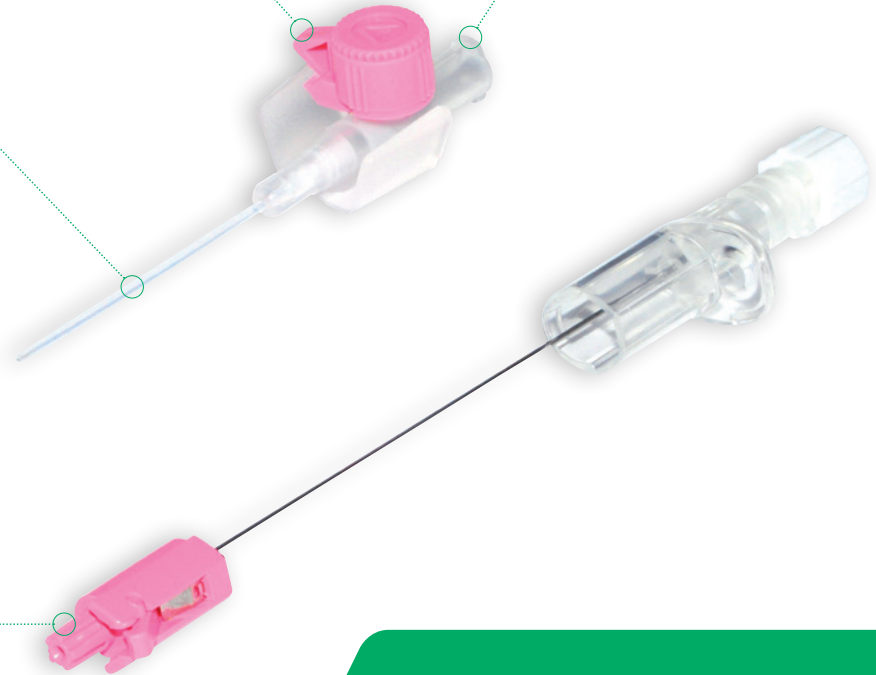

- **No change in procedure**
- **Less pain and risks of trauma for your patients**

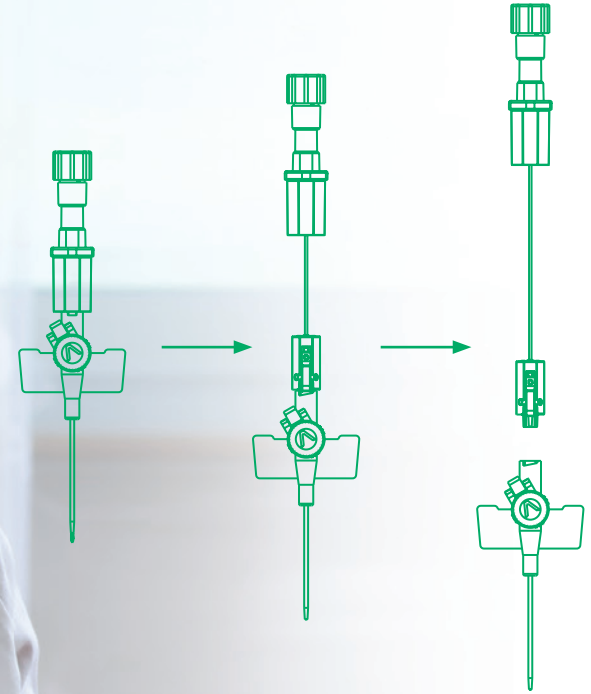

Did you know ?

Needlestick injuries and infections

- 1.2 million needlestick injuries to healthcare workers occur each year in Europe
- Globally, 2.5% of HIV infections and 40% of hepatitis B and C infections among healthcare workers are caused by needlestick injuries
- In 2010, the EU Commission recommended providing safety devices to all healthcare workers by 2012

- Commission of the European Communities, Council Directive COM(2009) 577 final -

Packaging

- Sturdy
- All the relevant information stands out
- Barcode



Customised kit for maximum barrier precautions

Build a Biovalve Safe Kit according to your own needs and further increase safety precautions and infection prevention.

Choose from a range of accessories including gloves, drapes, skin preparation ancillaries, cannula dressing, extension lines with needle-free connectors, record labels and tourniquet.

Please contact your Vygon representative for more information.



Biovalve safe references

Colour	Ext. Ø	Int. Ø	G	L	Gravity flow rate	Maximum flow rate under 350 psi	Code
Blue	0.9 mm	0.6 mm	22 G	25 mm	36 ml/mn	7.0 ml/mn	106.082
Pink	1.1 mm	0.8 mm	20 G	32 mm	60 ml/mn	11.9 ml/mn	106.102
Green	1.3 mm	1.0 mm	18 G	45 mm	90 ml/mn	17.1 ml/mn	106.122
White	1.5 mm	1.2 mm	17 G	45 mm	125 ml/mn	> 23.0 ml/mn	106.142
Grey	1.7 mm	1.4 mm	16 G	45 mm	180 ml/mn	> 23.3 ml/mn	106.172
Orange	2.1 mm	1.6 mm	14 G	45 mm	270 ml/mn	> 23.3 ml/mn	106.212



Laboratoires pharmaceutiques Vygon
5, rue Adeline - 95440 ECOUEN - FRANCE
Reception : +33 (0)1.39.92.63.63

Service clients France : +33 (0)1.39.92.63.81
Export customer service : +33 (0)1.39.92.64.15
Fax : +33 (0)1.39.92.64.44 - www.vygon.com

For further information, please contact:
questions@vygon.com

The specifications shown in this leaflet are for information only and are not, under any circumstances, of a contractual nature.